

## Installing Shutters using Fasteners

### Required for Installation:

Electric drill, 1/4" (6mm) drill bit, 3/8" (10mm) drill bit, hammer, and shutter fasteners.

(1/4" (6mm) carbide drill bit is required for stucco, hardboard, fibre cement, brick or masonry.)

For shutters up to 55", (1397mm) use four shutter fasteners per shutter. For shutters 55" (1397mm) and over, use six shutter fasteners per shutter. See figures at right.

For use on any surface including: wood, aluminium, vinyl, stucco, hardboard, brick, fibre cement, or masonry.

### How to remove old shutters:

To remove shutters, do not attempt to pull out the shutter fasteners. Simply use a pair of snips and slide them behind the shutter to cut the shutter fastener off at the shank.

### Step 1

Place the shutter next to the window and mark desired location against the wall or window.

### Step 2

Keep shutter fasteners aligned uniformly by drilling 1/4" (6mm) holes into the shutter and 2 1/2" (64mm) into the wall. On brick, position holes over mortar joints. Do not attach shutters at this time.

### Step 3

With the 1/4" (6mm) holes drilled into the shutter and wall, remove the shutter from the wall. Enlarge the holes in the shutter by using a 3/8" (10mm) drill bit.

### Step 4

Reposition the shutter against the wall. Grasp the shutter fastener supporting shank and push it through the shutter hole and into the wall surface. Tap the shutter fastener gently with a hammer to snug the shutter against the siding. Do not over tighten, or this will cause the shutter to dimple. Repeat this step for all holes.

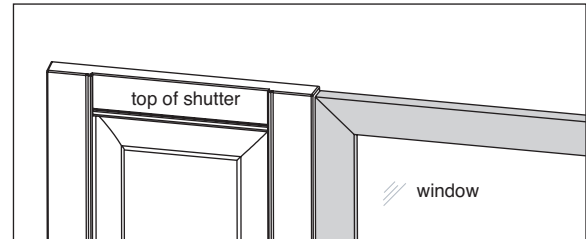

Four fastener application for shutters shorter than 55" (1397mm)

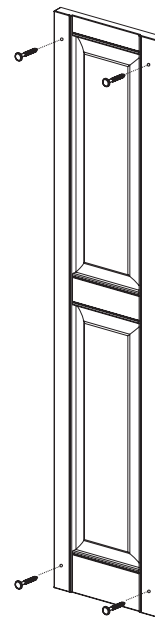

Six fastener application for shutters longer than 55" (1397mm)

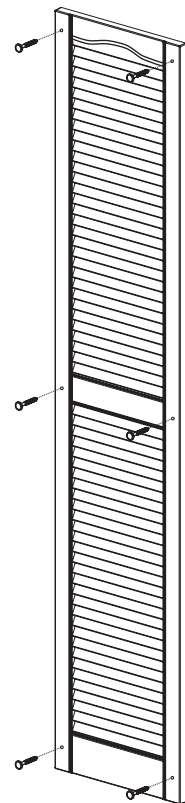

# Installing Shutters using Screws

## Required for Installation:

Electric drill,  $\frac{5}{16}$ " (8mm) and  $\frac{1}{4}$ " (6mm) drill bit, hammer.

( $\frac{1}{4}$ " (6mm) carbide drill bit is required for stucco, hardboard, fibre cement, brick, or masonry.)

For shutters up to 55" (1397mm), use four screws per shutter. For shutters 55" (1397mm) and over, use six screws per shutter. See figures at right.

For use on any surface including: wood, aluminium, vinyl, stucco, hardboard, brick, fibre cement, or masonry.

## Step 1

Place the shutter next to the window and mark desired location against the wall or window.

## Step 2

When installing shutters smaller than 55" (1397mm), drill (4)  $\frac{5}{16}$ " (8mm) holes in the locations shown at right. If the shutter is 55" (1397mm) and over, drill (4)  $\frac{5}{16}$ " (8mm) holes and (2)  $\frac{1}{4}$ " (6mm) holes in the locations shown in the diagram to the right.

## Step 3

Reposition the shutter against the wall and screw it into place using the screws provided. Do not over tighten the screws. When installing a shutter 55" (1397mm) and over, screw the two centre screws in first (the screws using the  $\frac{1}{4}$ " (6mm) holes).

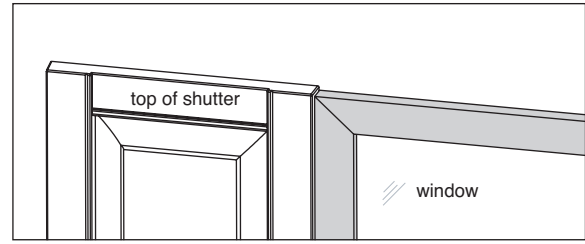

Four screw application for shutters shorter than 55"

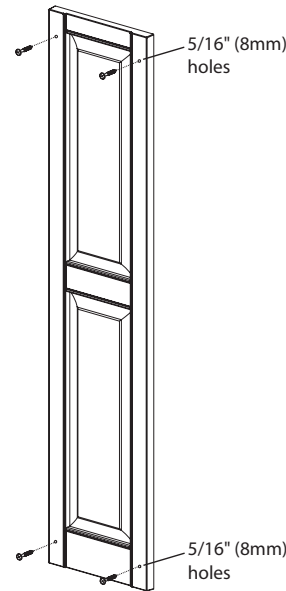

Six screw application for shutters longer than 55"

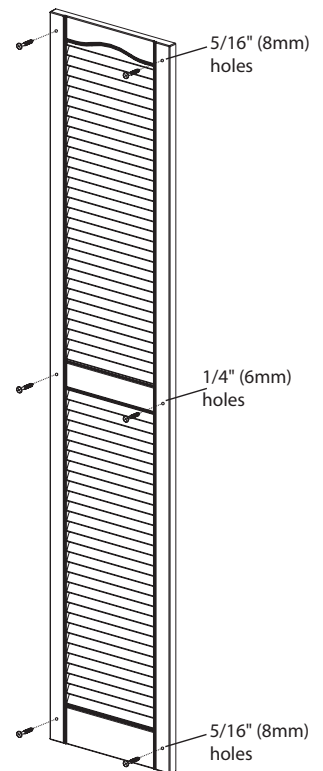

# Measuring Windows

## Steps to Measure and Select a Window Look

- Step 1 Measure the Width and Length of your Window Opening** to get the Exterior Window Opening dimensions (fig.1). Remember to include the window frame in your measurement.
- Step 2 Choose Shutter Style:** Louvre, Raised Panel, Louvre-Panel, or Board & Batten.
- Step 3 Choose Shutter Type:** Standard or Custom. **Note:** Not all shutter styles are available Standard and Custom. See Pricing Manual.
- Step 4 Determine Shutter Width.** **Note:** See charts in Pricing Manual for available widths of Standard or Custom shutters.
- Step 5 Determine Shutter Length.\*** **Note:** This number should be the same number as the window length determined in Step 1.
- Step 6 Choose a "TOP":** Header, Sunburst Kit, Sunburst, Elliptical Sunburst, Quarter Round Arch Top or Elliptical Arch Top.

### \*A note about shutter length.

Shutters are decorative and do not open and close. Because they are decorative, they don't have to match the window length exactly. They can be up to an inch (24mm) short or long and will still look fine on a window.

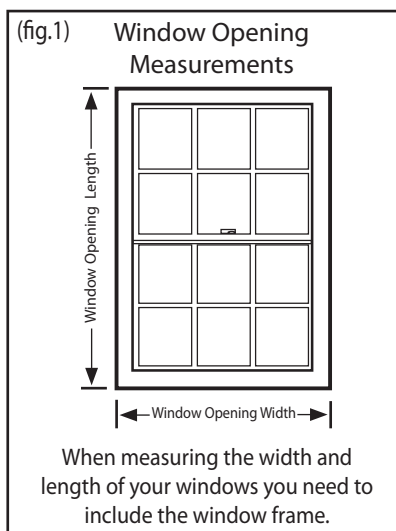

## Header Options

(**Note:** Header width is measured along the base width of the header for windows and doors)

### Determine the header width (2 options)

#### Option 1

Use window opening width measurement from step 1 on page 1.

#### Option 2

Use window opening width measurement from step 1 on page 1. Take shutter width from step 4 and double it. Add these two measurements together to get header width.

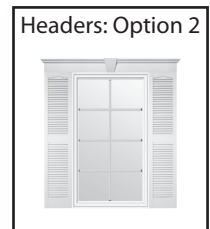

## Sunburst Options

**Note:** Use of half round or elliptical sunburst in a look is limited by the width of window opening and shutter width.

### Determine Sunburst Size

Use window opening width measurement determined in step 1 on page 1.

**Note:** Sunburst should be the same width as the window opening width.

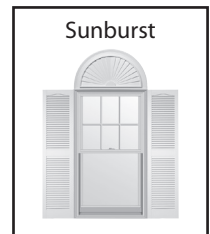

### Determine Elliptical Sunburst Size

The elliptical sunburst is available in 73 5/8" (1870mm) and 65 5/8" (1667mm) widths only. To see if this look will fit on your window, take the window width from step 1 on page 1 and subtract it from the sunburst widths. Take that number and divide by two. The final number would be your shutter width.



### Determine Sunburst Kit Size

The Sunburst Kit is available in size ranges. The Header part can be cut to fit the desired width. Use the window width determined in Step 1 on page 1. Add the shutter width determined in step 4 on page 1 two times. Order the Sunburst Kit that fits that size.

