

Installation Instructions – Window Headers

Note: The illustrations contained in these instructions use a 9" (229mm) Header and Base for examples. A 6" (152mm) Header and Base can be used just as easily.

Step 1

Measure the width of the window across the largest measurement to create Dim. "A". Also, draw a horizontal line 1/8" (3mm) above the window trim. This line will be used to properly space the Window Header from the window trim.

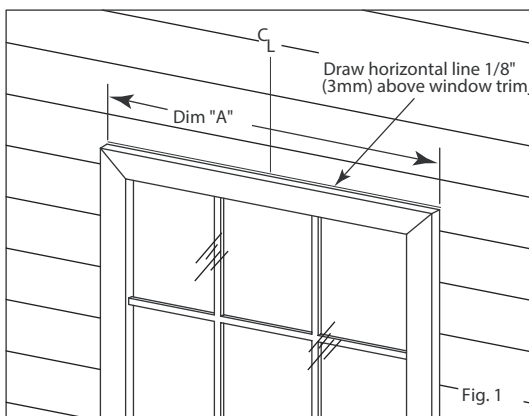

Note: IF HEADER DOES NOT NEED TO BE CUT, PROCEED TO STEP 5

Step 2A

If your window doesn't match the exact size of the Window Header right from the box, the Window Header will need to be cut. With the Window Header and Window Header Base assembled, mark the centre on the assembly.

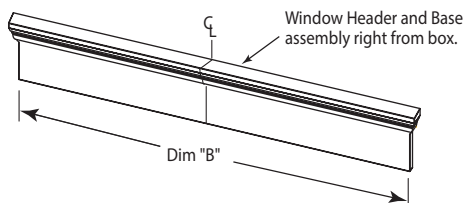

Step 2B

Next, subtract Dimension "A" from Dimension "B" and divide the result by 2. This will give you Dimension "C".

$$\frac{\text{Dim. "B"} - \text{Dim. "A"}}{2} = \text{Dim. "C"}$$

Step 2C

Transfer Dimension "C" to the Window Header Assembly. Dimension "C" will be transferred 2 times; once on each side of the centre line.

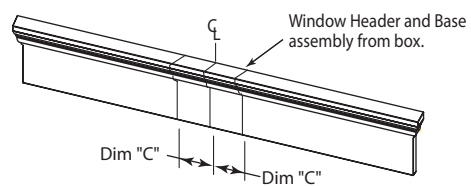

Step 3

Cut the Window Header and Window Header Base assembly at the lines created by Dimension "C".

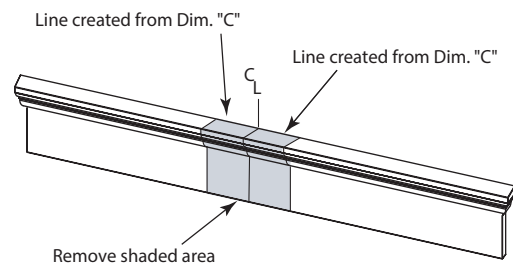

Step 4

Once the Window Header has been cut to the correct length, disengage the locking tabs and remove the Window Header from the Window Header Base. To release the locks, start at the open end of the cut Header Assembly and pull the wall of the Header away from the Header Base. Continue this process, working your way to the end of the cut Window Header Assembly.

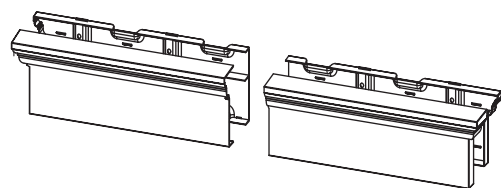

Step 5

Align the bottom of the Window Header Base to the line drawn $\frac{1}{8}$ " (3mm) above the window trim. Mate the two cut ends of the Window Header Base to each other. The preferred method of attaching the Window Header Base to the house is to use the shutter fasteners that are enclosed with the Window Header Kit. In order to install the shutter fasteners, $\frac{1}{4}$ " (6mm) holes must be drilled into the wall. Another method is to use screws. Use the elongated slots in the Header Base and attach the tray to the house using the screws provided with the Window Header. Be sure not to fasten the screws too tightly to allow for expansion and contraction. See figure below for slots for optional screw application.

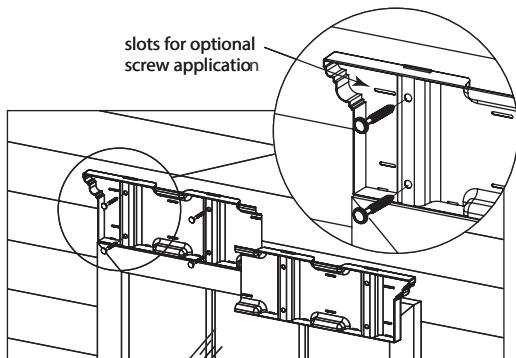

Step 6

With the Window Header Bases securely fastened to the wall, the Window Header can be snapped into place by engaging the locks.

Note: If your header was shipped assembled with a keystone, you're done. If you need to install the keystone, go to step 7.

Flat Panel

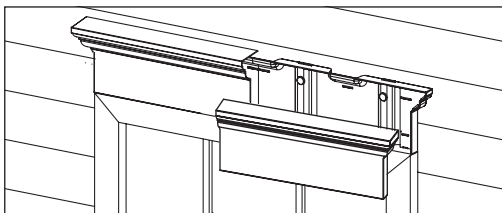

Classic Dentil

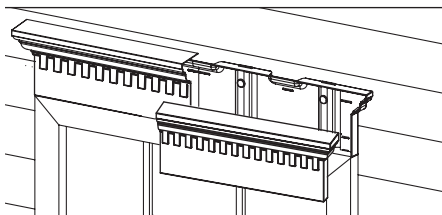

Note: If you are installing a classic dentil profile header, and the dentil teeth land on the sides of the keystone, it will need to be trimmed to properly snap in place. If not, proceed to step 7. If yes, trim thinned areas on the Keystone cover as shown below.

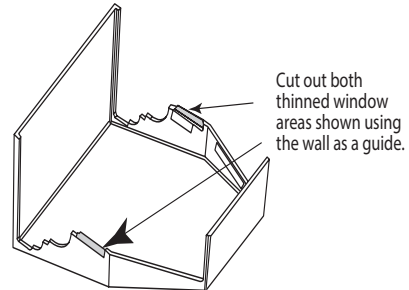

Step 7

Centre the Keystone Base over the Window Header Assembly. The tab at the bottom of the Keystone Base is to aid in installation. The bottom of the tab and the bottom of the Window Header should be flush. Screw the Keystone Base into place using the enclosed screws.

Flat Panel Keystone

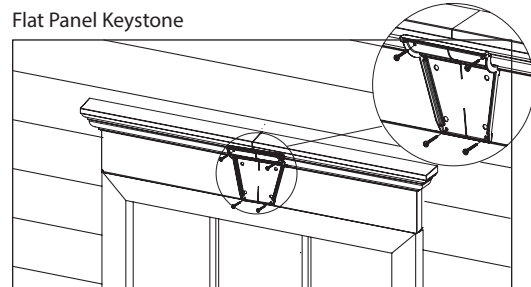

Classic Dentil Keystone

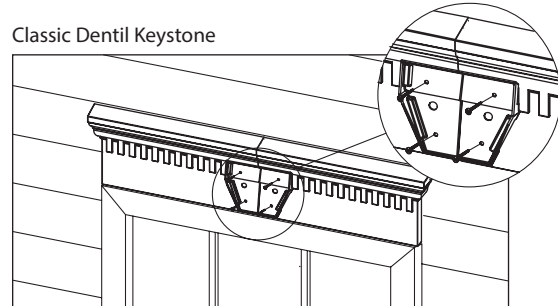

Note: shutter fasteners may be used to secure the Keystone Base to the Window Header. If shutter fasteners are being used, drill $\frac{1}{4}$ " (6mm) holes through the Window Header and Base as shown below to accept the shutter fasteners.

Flat Panel Keystone

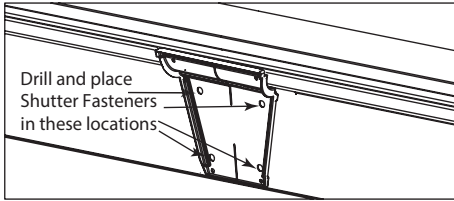

Classic Dentil Keystone

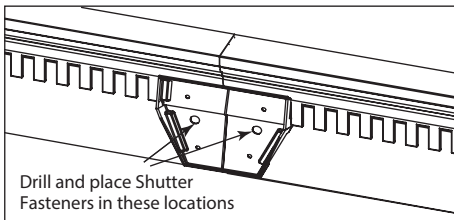

Step 9

Snap the Keystone over the Keystone Base. Be sure the lock tabs engage.

Flat Panel

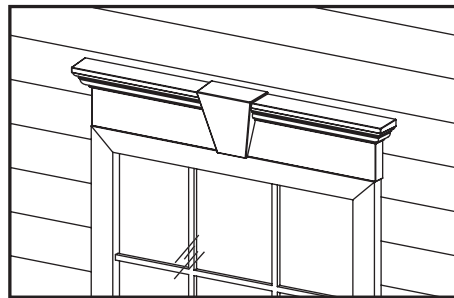

Classic Dentil

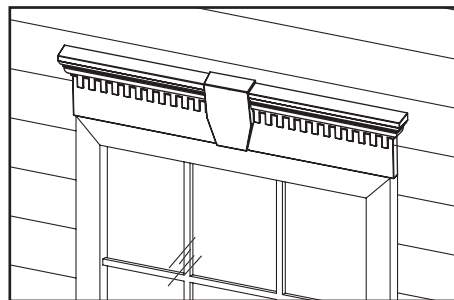

Measuring Windows

Steps to Measure and Select a Window Look

- Step 1 Measure the Width and Length of your Window Opening** to get the Exterior Window Opening dimensions (fig.1). Remember to include the window frame in your measurement.
- Step 2 Choose Shutter Style:** Louvre, Raised Panel, Louvre-Panel, or Board & Batten.
- Step 3 Choose Shutter Type:** Standard or Custom. **Note:** Not all shutter styles are available Standard and Custom. See Pricing Manual.
- Step 4 Determine Shutter Width.** **Note:** See charts in Pricing Manual for available widths of Standard or Custom shutters.
- Step 5 Determine Shutter Length.*** **Note:** This number should be the same number as the window length determined in Step 1.
- Step 6 Choose a "TOP":** Header, Sunburst Kit, Sunburst, Elliptical Sunburst, Quarter Round Arch Top or Elliptical Arch Top.

*A note about shutter length.

Shutters are decorative and do not open and close. Because they are decorative, they don't have to match the window length exactly. They can be up to an inch (24mm) short or long and will still look fine on a window.

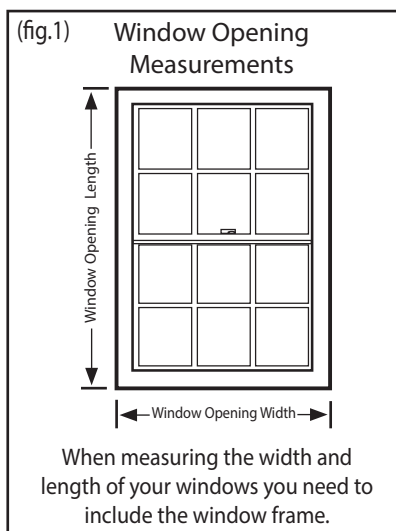

Header Options

(**Note:** Header width is measured along the base width of the header for windows and doors)

Determine the header width (2 options)

Option 1

Use window opening width measurement from step 1 on page 1.



Option 2

Use window opening width measurement from step 1 on page 1. Take shutter width from step 4 and double it. Add these two measurements together to get header width.

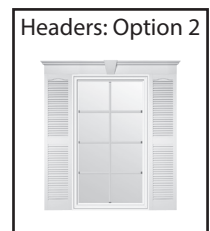

Sunburst Options

Note: Use of half round or elliptical sunburst in a look is limited by the width of window opening and shutter width.

Determine Sunburst Size

Use window opening width measurement determined in step 1 on page 1.

Note: Sunburst should be the same width as the window opening width.

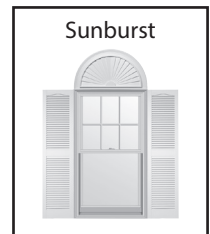

Determine Elliptical Sunburst Size

The elliptical sunburst is available in 73 5/8" (1870mm) and 65 5/8" (1667mm) widths only. To see if this look will fit on your window, take the window width from step 1 on page 1 and subtract it from the sunburst widths. Take that number and divide by two. The final number would be your shutter width.



Determine Sunburst Kit Size

The Sunburst Kit is available in size ranges. The Header part can be cut to fit the desired width. Use the window width determined in Step 1 on page 1. Add the shutter width determined in step 4 on page 1 two times. Order the Sunburst Kit that fits that size.



Measuring Doors

Door Surrounds are comprised of a Pilaster Kit and a Header plus Keystone.

The Pilaster comes in one size: 96" / 8 feet (2438mm) long. It can be cut to fit the door exactly.

The only measurement that you need is for the header.

Note: Header width indicates the width along the base of the header.

Determine the Header Width

- A. Measure door opening width as shown in fig. 2. Remember to include the frame in your measurement.
- B. Add the width of the pilaster two times ($6\frac{7}{8}" \times 2 = 13\frac{3}{4}"$) (174.5 mm x 2 = 349mm) to the above width measurement.
- C. The final number is the header width for the door surround.

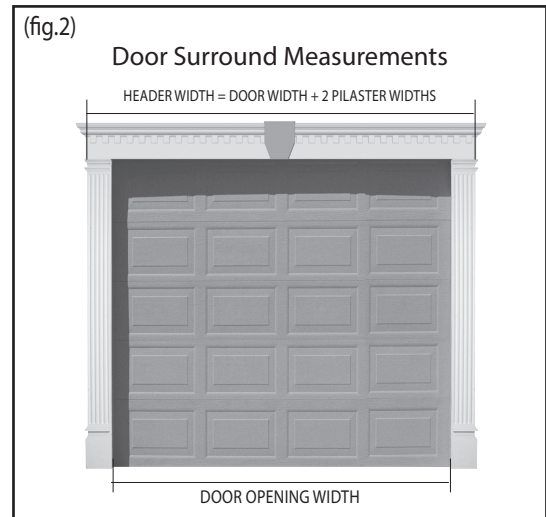

When measuring the width of your door be sure to include the frame.